

Installation Instructions



Plain Cable

Pass one cable end through the DobyGrip in the direction of the arrow on the casing. **1**
 Now pass the cable over or through the suspension point. Note: Always ensure that the suspension point is suitable and capable of supporting the load being suspended. Pass the cable back through the remaining entry into the DobyGrip unit **1** in the direction of the arrow on the casing then pull the cable **(B)** tight. Always ensure a minimum of **75mm** excess cable **(A)** protrudes through the unit. Pass the end of cable **(B)** through a second DobyGrip unit in the direction of the arrow on the casing. **2**

Pull the cable **(B)** through the unit and pass through the suspension point of the item being suspended ensuring that the contact point between the cable and the item being supported will not damage the cable. Pass the tail of the cable back through the remaining entry into the DobyGrip in the direction of the arrow on the casing leaving a minimum of **75mm** protruding from the DobyGrip. **3**

Pull the required length of cable through the unit to position the item being suspended at the desired height. The height can easily be adjusted by lifting the load from the DobyGrip, pushing back the adjusting slide *lever and repositioning at the desired level.

* Adjustment must be made using the main wire inward lever **(1)** on diagram to the right, **not** the lever where the wire is exiting the unit, prior to being cut. Once all heights are fixed excess cable can be cut back, always ensure a minimum of **75mm** excess cable protrudes through the unit.

Safe Working Loading diagram (SWL)

The diagram below illustrates the typical loading configuration for the DobyGrip range when the suspension wire is away from vertical. If, as the diagram states, that the duct/pipe is required to be closer to the DobyGrip unit for height restrictions or services etc, then the Safe Working Load (SWL) table overleaf will show the permitted angles and the reduction in the suspended loads. For more information on DobyGrip suspension heights then please refer to the sales office for recommendations.

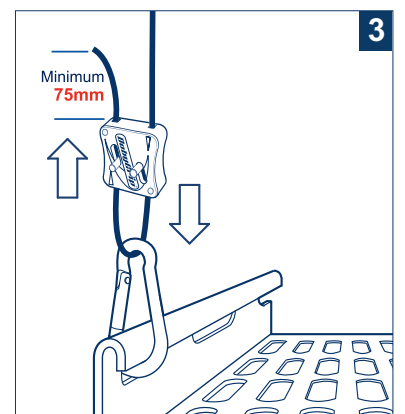
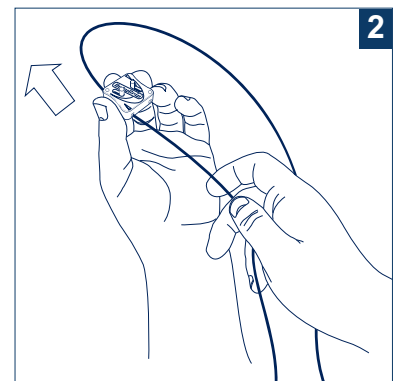
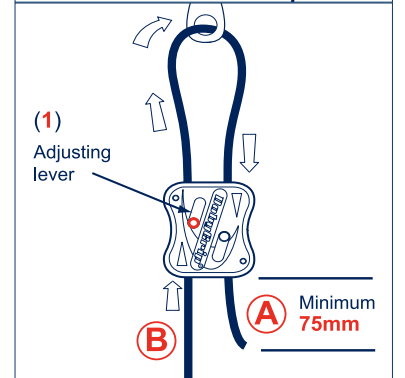
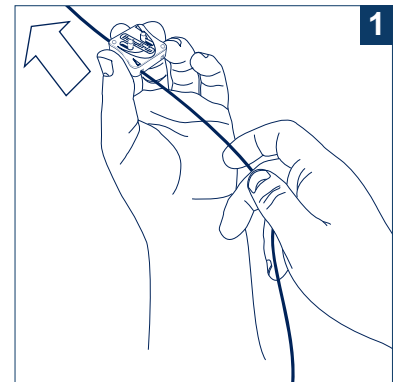
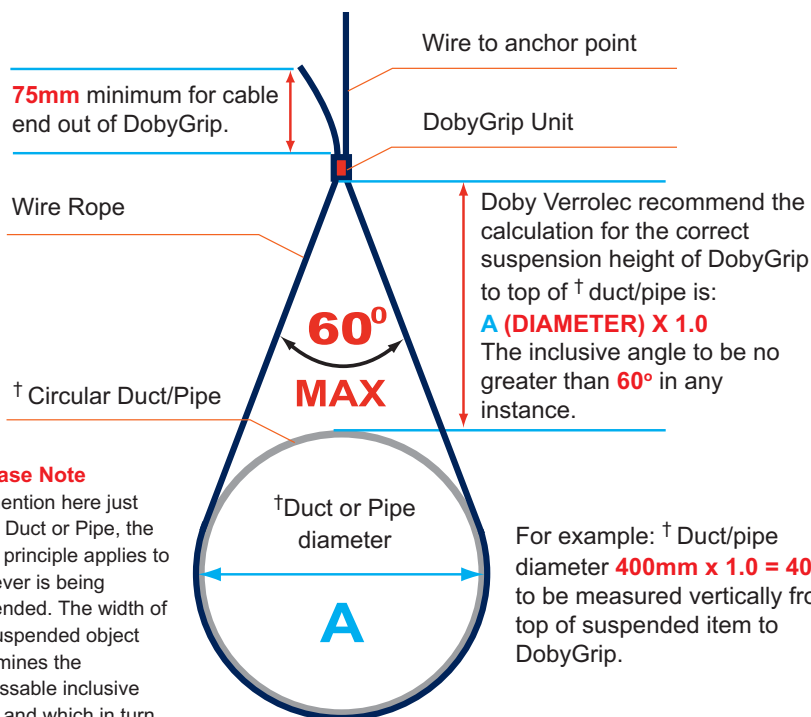

WARNING

Load ratings (SWL) are based on vertically suspended wire rope. If any part of the wire rope is NOT vertical refer to the safe working load table (SWL) or contact your local sales office for further information.



Installation Instructions



Cable with loop only

Having selected the most suitable DobyGrip unit (refer to Brochure for technical details) and cable size for the load being suspended; pass the tail of the cable over or through the suspension point. Note: Always ensure that the suspension point is suitable and capable of supporting the load being suspended. Pass the tail of the cable through the loop formed in the cable and pull tight, ensuring that the contact point between the cable and the supporting structure will not damage the cable. **4**

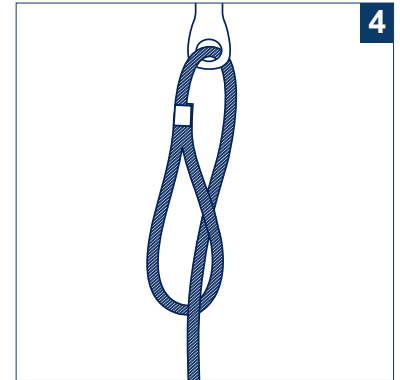

Pass tail of the cable through the DobyGrip in the direction of the arrow on the casing. **5**

Point to remember...

■ If using the DobyGrip in conjunction with our wire on a reel, make sure the wire has been cut to length correctly using approved wire cutters to guarantee the shape to the wire end and therefore ease of use through the DobyGrip unit.

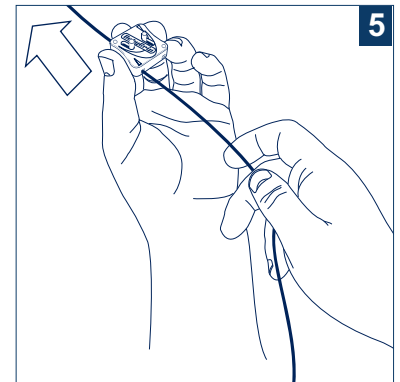

Pass the tail of the cable back through the suspension point or accessory to be supported, ensuring that the contact point between the cable and the item being supported will not damage the cable. Pull the cable through the unit ensuring that once all heights are fixed any excess cable be cut back and always ensure a minimum of **75mm** excess cable protruding through the unit. **6**

Movement: Do not in any instance use the DobyGrip system to suspend moving services or objects that are subject to sudden or repeated dynamic movement. DobyGrips and accessories are designed for static only installations that are either, HVAC, mechanical, signage or electrical in nature. Refer to customer services for suitability of any other application or installation method.

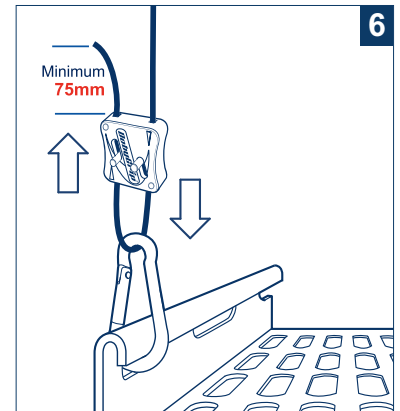

Safe Working Load (SWL) table

Load ratings for all of the DobyGrip range are based solely on the suspension being vertical. Therefore the more the wire rope is moved away from vertical then extra sideways loads are applied, reducing the holding capacity of the single DobyGrip. The effect this has in turn on the suspension unit is shown in the table and diagram overleaf.

The diagrams shown in this document are for guidance purposes only, when working with steel wire care must always be taken to avoid accidents and suitable protective clothing should be worn.



Safe Working Load (SWL) angles from vertical					
DobyGrip	0°	15°	30°	45°	60°(Max)
Size 1 (SWL 10kg / 22lb)	10kg (22lb)	9kg (21lb)	8kg (18lb)	7kg (15lb)	5kg (11lb)
Size 2 (SWL 50kg / 110lb)	50kg (110lb)	48kg (105lb)	43kg (95lb)	35kg (77lb)	25kg (55lb)
Size 3 (SWL 100kg / 220lb)	100kg (220lb)	96kg (211lb)	86kg (189lb)	70kg (154lb)	50kg (110lb)
% of Loading	100	90	80	70	50

Wire to and from the DobyGrip shall not exceed an inclusive angle of 60° in any instance. The information contained in the SWL table here and diagram overleaf applies to both types of installation shown.

WARNING

Load ratings (SWL) are based on vertically suspended wire rope. If any part of the wire rope is NOT vertical refer to the safe working load table (SWL) or contact your local sales office for further information.

